



Installation manual

Manual operated ALU-Slide ECO

Manual operated ALU-Slide AVANT

The new Generation of
Aluminium sliding gates

ALUCONNECT

Manual for the installer

Dear Customer,

We would like to thank you for your trust and for choosing this sliding gate. This manual contains all required information to quickly ensure you become familiar with this product.

This manual is meant for the installer and ensures that the installer can install the sliding gate correctly. The table of contents will assist you in finding the information that you need in this manual.

The sliding gate must be installed by a certified and professional installer, who uses an installation diagram and works in accordance with the applicable legislation and regulations.

We recommend that you carefully study the information in this manual before working with the product.

Ensure that you act in accordance with the instructions contained in this manual when installing the sliding gate.



A user manual is available for this sliding gate.
This manual contain detailed information for the user.

You can request these manuals from the installer of your sliding gate.

For more informaton or to order manuals, contact:

Disclaimer

The sliding gate may only be used for closing passages dynamically. Aluconnect cannot be held liable for any damage caused by improper, incorrect or unwise use. Read and fully understand this manual.

If you deviate from the described actions in the installation manual, any guarantees or liability of the manufacturer will be null and void. The manufacturer cannot accept any liability for consequential damages.

There are also requirements for the installation of the gate. The installation instructions must always be followed, and installation must be carried out by a qualified and skilled installer in compliance with applicable laws and regulations. Safety must be ensured at all times so that users and third parties can use the sliding gate safely. The fence installer is responsible for proper installation. If there are any questions or uncertainties regarding installation, the installer may contact Aluconnect.

The sliding gate is supplied in accordance with EU directives and regulations:

305/2011 EU Construction Product Regulation (CPR)

Where the sliding gates are produced in accordance with the EN 13241 standard and the related supporting EN 12604, EN12605 and EN12635 standards.

A Declaration of Performance (DoP) and a CE mark are drawn up for the sliding gates.

The combined CE Declaration of Performance can be found at the back of the user manual.

The CE mark can be found on the nameplate. This figure is added to the guidepost and may never be removed.

Table of Content

| | |
|---|-----------|
| 1. Introduction | 5 |
| 1.1. Manufacturer..... | 5 |
| 2. Safety aspects..... | 5 |
| 2.1. Symbols | 5 |
| 2.2. General safety | 6 |
| 2.3. Entrapment Hazard..... | 7 |
| 2.4. Wind load regulation..... | 8 |
| 3. General..... | 9 |
| 3.1. Models | 9 |
| 3.2. Dimensions | 10 |
| 3.2.1. Standard heights ALU-Slide ECO | 10 |
| 3.2.2. Standard heights ALU-Slide AVANT..... | 10 |
| 3.3. Explanation gate components..... | 10 |
| 3.4. Sliding direction | 11 |
| 3.4.1. DIN Right..... | 11 |
| 3.4.2. DIN Left..... | 11 |
| 3.5. Locking..... | 12 |
| 4. Gate description | 12 |
| 4.1. Technical data gate..... | 12 |
| 5. Delivery scope | 13 |
| 5.1. Standard components..... | 13 |
| 6. Installing the sliding gate..... | 14 |
| 6.1. General..... | 14 |
| 6.2. Required tools..... | 14 |
| 6.3. Preparing the ground | 15 |
| 6.4. Installation of the sliding gate..... | 16 |
| 6.5. Installation of the slam portal | 17 |
| 6.6. Installing the rear support roller | 18 |
| 6.7. Underfilling base plate / central catcher | 18 |
| 6.8. Lock | 19 |
| 6.9. Gate keep..... | 19 |
| 6.10. Wind security handle..... | 19 |
| 7. Transfer to the user..... | 20 |
| 7.1. Instructions..... | 20 |
| 8. Environment, disassembly, storage and transport | 21 |
| 8.1. Environment..... | 21 |
| 8.2. Disassembly..... | 21 |
| 8.3. Storage and transport | 21 |
| 9. Notes..... | 22 |

1. Introduction

1.1. Manufacturer



Aluconnect B.V.

Koperbijn 9

5443 PV Haps

Phone: +31 (0)88 33 43 000

E-mail: info@aluconnect.nl

Website: www.aluconnect.nl

2. Safety aspects

2.1. Symbols



Warning

Instructions that include this symbol warn in relation to the risk of damage to the machine or breakdowns if the instructions are not closely followed.



Entrapment hazard

Instructions that include this symbol warn in relation to physical injury if the instructions are not closely followed.



Electrocution danger

Instructions that include this symbol warn in relation to the danger due to electricity if the instructions are not closely followed.

2.2. General safety



IMPORTANT

- All installation work must be performed by professional and certified personnel. The installation company is responsible for the deployment of professional and certified personnel.
- The sliding gate may only be commissioned after the sliding gate has been completely installed and tested.
- The installation of the sliding gate is very easy. We do, however, recommend that you carefully read the installation instructions before you start installing. This will ensure that installation errors are prevented. The manufacturer cannot be held liable for damage to the drive or damage as a result of incorrect installation.
- The sliding gate must always be installed horizontally and may only be used for closing entrances dynamically.
- The sliding gate may not be operated by children or people with an impairment. Adults must supervise to ensure that children do not play with or within the range of the sliding gate.
- Parents/carers are responsible for their children.

- Ensure that the instructions specified in the installation manual are followed and observed. Any other type of use may cause unpredictable hazards and is therefore prohibited.
- Use the correct personal protective equipment such as work gloves, safety shoes (at least class S3), safety goggles, hearing protection, a dust mask and protective overalls.
- Only use approved lifting supports for moving heavy loads. Always perform lifting activities with more than one person even when using lifting supports. The maximum permitted weight for lifting is 25 kg per person.
- Cordon off the work area before and during installation to ensure no unauthorised people have access. Safeguard public safety depending on the situation. Pay, for example, near schools additional attention to the safety of children.
- The gate wing may not be increased in weight or the surface area of the gate infill may not be increased. If required, contact your gate supplier.
- It is mandatory to install a protection to prevent the gate wing to run out of her guiding systems. For this purpose, the sliding gates are equipped with a safety bolt on both sides of the bottom profile.
- It is mandatory to be able to lock a sliding gate at all times to prevent unintentional movement. Manual operated sliding gates are standard supplied with a wind security handle. . For automated sliding gates, the installer must inform the user that an unlocked sliding gate must be secured against unintentional movement. Several options are available for this and are available from your supplier of the sliding gate.
- PEOPLE MAY NOT HITCH A LIFT ON THE SLIDING GATE.
- Only operate an unlocked and manually operated sliding gate with the handle. Use the full handle to avoid the risk of entrapment.
- Ensure that the slide area is always free from obstruction.
- Train the user, issue the user manual to the user and test the correct operation of the sliding gate upon the delivery of the sliding gate.
- Keep waste separate. Obtain information in your region about the possibilities for a safe and correct disposal.



INSTALLATION

- Protect against direct sunlight and rain when installed outside.
- Only install on a level surface!
- The ambient temperature may not be lower than -20 °C and may not be higher than + 50 °C.
- Air humidity must be between 30 - 90% RH.
- The gate must have an end stop in the opened and closed positions so that it cannot be slid out of the guide.
- The manual gate is not self-locking and a wind security handle must be installed on the sliding gate.
- For two sliding gates sliding toward each other, mount the ramp, which is mounted on the floor where the two sliding gates meet when in the closed position.



ENTRAPMENT HAZERD

- The sliding gate may only be opened or closed under the supervision of and by people with sufficient experience and knowledge regarding the sliding gate.
- Only operate an unlocked and manually operated sliding gate with the handle. Use the full handle to avoid the risk of entrapment.
- An uncontrolled movement of the gate wing (for example, caused by wind) must be prevented both in an open and a closed condition. Manual operated sliding gates are standard supplied with a wind security handle and for unlocked automated sliding gates, there are wind security handles available. When the gate wing opens or closes in an uncontrolled manner, structural deformation of the gate can occur, which may represent a hazard for people and the surrounding area.

An unlocked and manually operated sliding gate may never be opened or closed unsupervised!

2.4. Wind load regulations



WIND LOAD

The sliding and swing gates from Aluconnect are manufactured in accordance with the EN 13241-1 standard. The EN 12424 standard is observed with regard to the wind load.

- Wind class 2 is applied as wind load either 450 Pa.
This means that the gate withstand wind speeds of up to 102 km/h in the closed position.
- For industrial sliding gates up to and including 8000 mm width, a wind load is answered to wind class 3 either 700 Pa.
This means that the gate can withstand wind speeds of up to 133 km/h in the closed position.

| Wind strength | Classification EN 12424 | Dynamic pressure Pa= N/m ² | Wind force Beaufort | Winds speed in m/s | Wind speed in km/h |
|-----------------|-------------------------|---------------------------------------|---------------------|--------------------|--------------------|
| Calm | Class 0 | 0 | 0 | 0 - 0,2 | 0 |
| Strong gale | Class 1 | 300 | 9 | 20,8 - 24,4 | 75 - 88 |
| Violent storm | Class 2 | 450 | 10 | 24,5 - 28,4 | 89 - 102 |
| Hurricane | Class 3 | 700 | 12 | 32,7 - 36,9 | 118 - 133 |
| Heavy hurricane | Class 4 | 1000 | 13 | 37,0 - 41,4 | 134 - 149 |

NOTE:

The gate may only be set in motion at maximum of 50% of the wind speed in the respective class
This applies to both manual and automated gates.

- For class 2, the gate may not move if the wind speed exceeds 51 km/h.
A wind speed of 51 km/h matches wind force 6 - 7 accordance with the Beaufort wind scale.
- For class 3, the gate may not move if the wind speed exceeds 66 km/h.
A wind speed of 66 km/h matches wind force 8 accordance with the Beaufort wind scale.

(See table below).

| Windforce | Dynamic pressure Pa= N/M ² | Wind force Beaufort | Wind speed in m/s | Wind speed in km/h |
|---------------|---------------------------------------|---------------------|-------------------|--------------------|
| Strong breeze | 71,6 - 116,7 | 6 | 10,8 - 13,8 | 39 - 49 |
| High wind | 117,7 - 179,5 | 7 | 13,9 - 17,1 | 50 - 61 |
| Stormy | 181,3 - 262,4 | 8 | 17,2 - 20,7 | 62 - 74 |

3. General

3.1. Models

Below you can see the versions used in the automated sliding gates, all sliding gates can be made in both a single and 'sliding towards each other' versions:



3.2. Dimensions

3.2.1. Standard heights ALU-Slide ECO

Design: 955, 1155, 1355, 1555, 1755, 1955 mm.
 Industrial: 1000, 1250, 1500, 1800, 2000, 2500 mm.
 Industrial Dura: 1000, 1200, 1400, 1600, 1800, 2000, 2200, 2400 mm.

3.2.2. Standard heights ALU-Slide AVANT

Industrial: 1000, 1250, 1500, 1800, 2000, 2500mm.
 Industrial Dura: 1000, 1200, 1400, 1600, 1800, 2000, 2200, 2400mm.

| Passage Sliding gate | Length Wing | ALU-Slide ECO Industrial | ALU-Slide ECO Design | ALU-Slide AVANT Industrial |
|--|---------------------------|--------------------------|----------------------|----------------------------|
| Width dimension (mm) between the posts | Width dimension (mm) Wing | | | |
| 3000 | 4600 | ✓ | ✓ | ✓ |
| 4000 | 5700 | ✓ | ✓ | ✓ |
| 5000 | 6700 | ✓ | ✓ | ✓ |
| 6000 | 8200 | ✓ | ✓ | ✓ |
| 7000 | 9200 | ✓ | ✓ | ✓ |
| 8000 | 10700 | ✓ | | ✓ |
| 9000 | 11700 | | | ✓ |
| 10000 | 13200 | | | ✓ |
| 11000 | 14200* | | | ✓ |
| 12000 | 15900* | | | ✓ |

* The wing is being delivered in 2 pieces and needs to be screwed together on site.

3.3. Explanation gate components

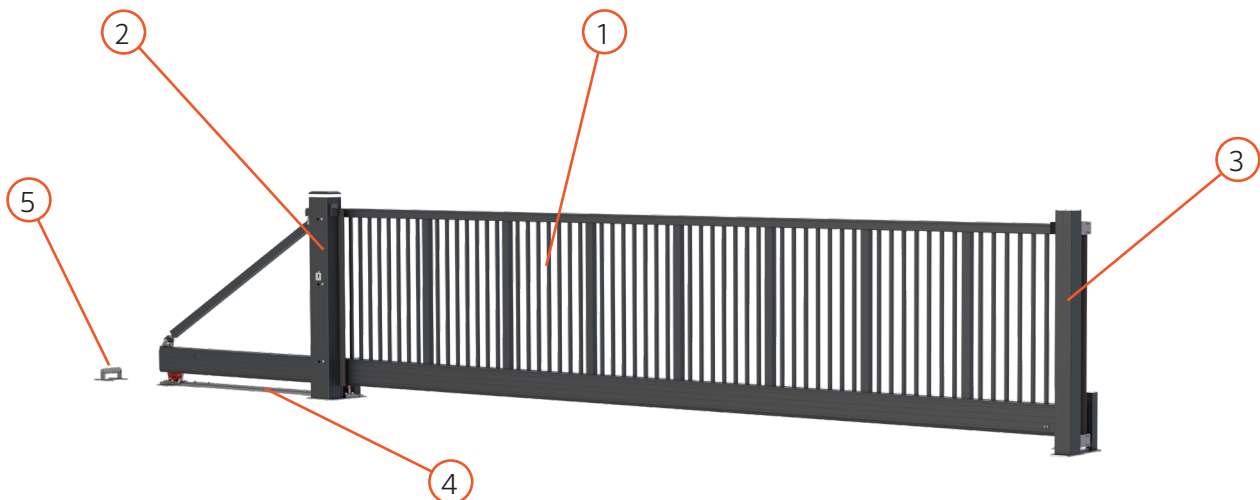

| | |
|--------------|-----------------------|
| 1 Gate wing | 4 Tandem set |
| 2 Drive post | 5 Rear support roller |
| 3 Slam post | |

3.4. Sliding direction

In practice, we refer to the sliding direction when opening when you are standing on the road side and looking at the sliding gate..

For example:

- DIN Right when viewed from the outside and opening to the right
- DIN Left when viewed from the outside and opening to the left

3.4.1. DIN Right

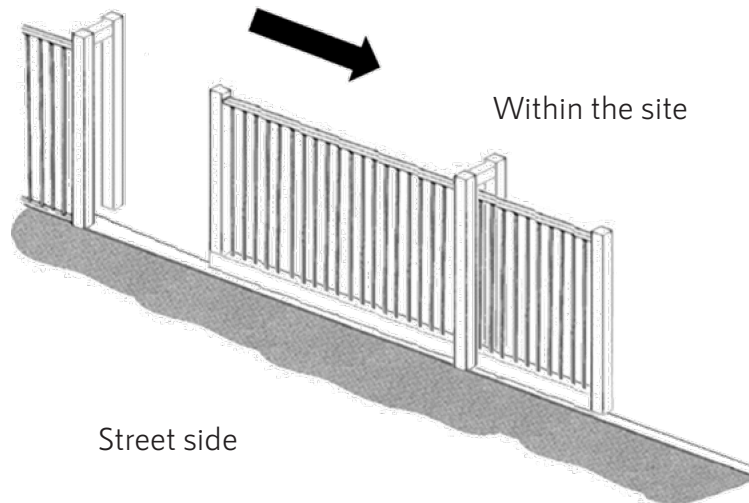

3.4.2. DIN Left

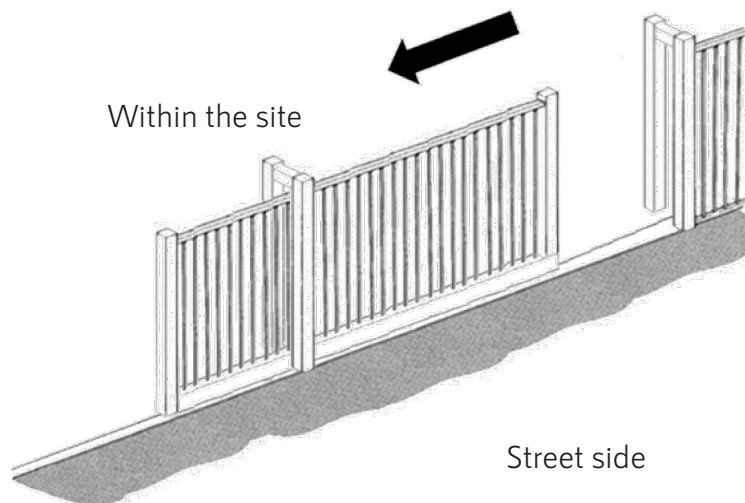

3.5. Locking

You must always be able to lock a manual sliding gate or an automatic sliding gate that is unlocked. For this, a wind security handle must be installed on the sliding gate.

Manual operated sliding gates are standard supplied with a wind security handle.

For automated sliding gates, the installer must inform the user that an unlocked sliding gate must be secured against unintentional movement. The user or the installer can provide the sliding gate with a locking system. This can be ordered optionally from the sliding gate supplier.

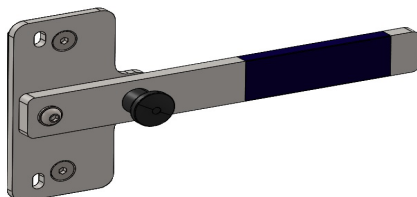

4. Gate description

4.1. Technical data gate

| Sliding gate Width dimension (mm) between posts | Sliding gate Length (mm) gate wing | Type | C-profile lower beam | Upper beam profile | Guide post | Slam post 150x150 | Head beam profile 100x80 | Vertical beam profile 80x60 |
|--|--|----------------------------|-------------------------|-----------------------|------------|----------------------|-----------------------------|-----------------------------------|
| 3000 | 4600 | ALU-Slide ECO Design | 180x160 | 140x65 | 1-legged | ✓ | ✓ | ✓ |
| | | ALU-Slide ECO Industrial | | | | | | |
| | | ALU-Slide AVANT Industrial | 250x160 | 140x75 | | | | |
| 4000 | 5700 | ALU-Slide ECO Design | 180x160 | 140x65 | 1-legged | ✓ | ✓ | ✓ |
| | | ALU-Slide ECO Industrial | | | | | | |
| | | ALU-Slide AVANT Industrial | 250x160 | 140x75 | | | | |
| 5000 | 6700 | ALU-Slide ECO Design | 180x160 | 140x65 | 1-legged | ✓ | ✓ | ✓ |
| | | ALU-Slide ECO Industrial | | | | | | |
| | | ALU-Slide AVANT Industrial | 250x160 | 140x75 | | | | |
| 6000 | 8200 | ALU-Slide ECO Design | 180x160 | 140x65 | 1-legged | ✓ | ✓ | ✓ |
| | | ALU-Slide ECO Industrial | | | | | | |
| | | ALU-Slide AVANT Industrial | 250x160 | 140x75 | | | | |
| 7000 | 9200 | ALU-Slide ECO Design | 180x160 | 140x65 | 1-legged | ✓ | ✓ | ✓ |
| | | ALU-Slide ECO Industrial | | | | | | |
| | | ALU-Slide AVANT Industrial | 250x160 | 140x75 | | | | |
| 8000 | 10700 | ALU-Slide ECO Industrial | 180x160 | 140x65 | 1-legged | ✓ | ✓ | ✓ |
| | | ALU-Slide AVANT Industrial | 250x160 | 140x75 | 1-legged | ✓ | ✓ | ✓ |
| 9000 | 11700 | ALU-Slide AVANT Industrial | 250x160 | 140x75 | 1-legged | ✓ | ✓ | ✓ |
| 10000 | 13200 | ALU-Slide AVANT Industrial | 250x160 | 140x75 | 1-legged | ✓ | ✓ | ✓ |
| 11000 | 14200 | ALU-Slide AVANT Industrial | 250x160 Connected | 140x75 Connected | 2-legged | ✓ | ✓ | ✓ |
| 12000 | 15900 | ALU-Slide AVANT Industrial | 250x160 Connected | 140x75 Connected | 2-legged | ✓ | ✓ | ✓ |

- For manually operated sliding gates ≤ 10000 mm wide, the dimensions of a 1-legged guide post is 150x150 mm and for a width > 10000 mm, the size of a 2-legged guide post is 150x150/150x150 mm.
- For automated sliding gates ≤ 10000 mm wide, the dimensions of a 1-legged guide post is 250x180 mm and for a width > 10000 mm, the size of a 2-legged guide post is 250x180/150x150 mm.

5. Delivery scope

5.1. Standard components

The sliding gates consist of different components.

You can find which standard components make up the different gates by visiting the Aluconnect website. www.aluconnect.nl

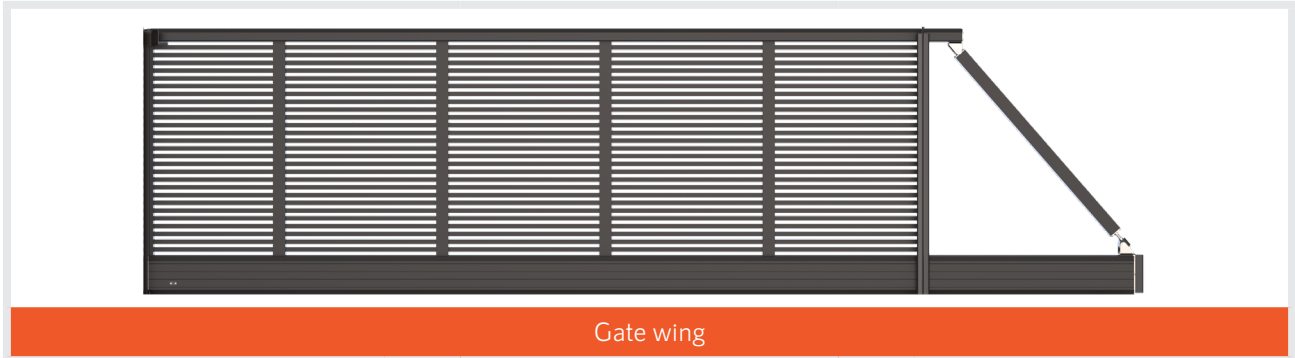

6. Installing the sliding gate









6.1. General

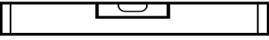
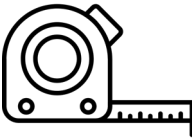

NOTE

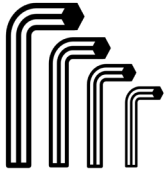
- Cordon off the work area before and during installation to ensure no unauthorised people have access. The safety of third parties must be safeguarded.
- Use the correct personal protective equipment.
- All installation work must be performed by professional and certified personnel.

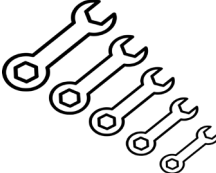
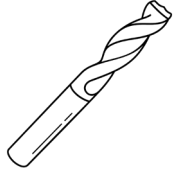
6.2. Required tools

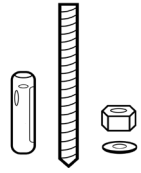
| | | |
|--|---|--|
|  Shovel |  Hammer |  Level |
|  Measuring tape |  Trowel |  Allen wrench set |
|  Screwdriver |  Wrench set |  Drill |
|  Hole cleaner |  Air pump |  Anchor set |

6.3. Preparing the ground

Ensure that the entire working area of the gate is level and free from obstructions.

See the foundation plan for the location determination.

Prepare possible accessories.

See the foundation plan.

Determine the 0 position for the gate and build the formwork for the foundations.

See the foundation plan

Pour the concrete. Allow the concrete to dry and harden sufficiently in accordance with the concrete specifications.

The foundations must be laid using poured concrete (concrete class B25)

The foundations must have a concrete mesh that has a dimension of at least 6 mm with a maximum mesh width of 150 mm, positioned under the centre of the foundations and over the full length and width.

Draw the holes for the guide portal and guide wheels or installation plate on the foundations. Use the foundation plan for this. Drill the holes using an 18 mm drill bit.



NOTE

Do not yet drill the holes for the slam portal and the rear support roller.

Ensure that all components are in 1 line on the foundations.

- o Guide portal
- o Slam portal
- o Tandem set
- o Rear support roller

Brush the drilled holes.

Remove all dust and grit from the drilled hole using an air pump.

Install the chemical capsules.

Insert the threaded rods with a rotational movement in the drilled hole. The threaded rods must at least protrude by 60 mm above the foundations.

Allow the chemical anchors to harden in accordance with the specifications.

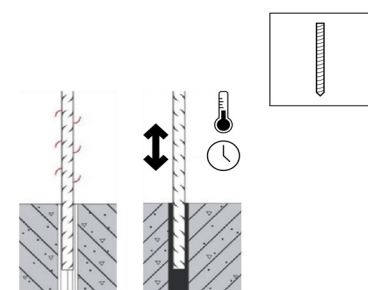
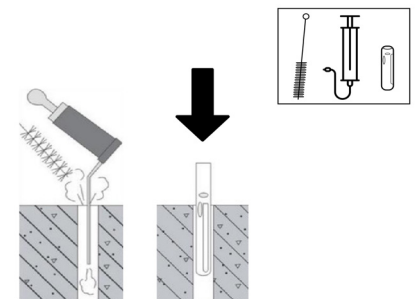
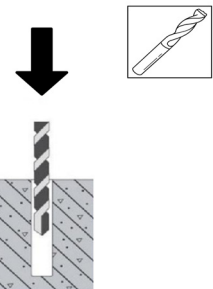
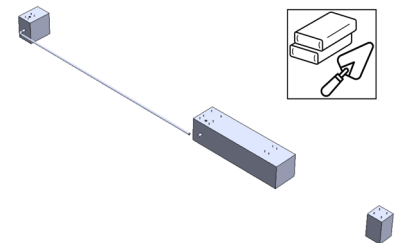
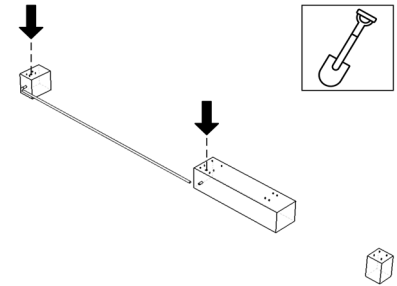
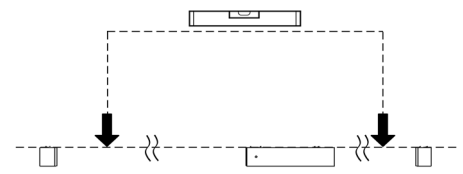

6.4. Installation of the sliding gate



IMPORTANT

- Only use approved lifting supports for moving heavy loads. Always perform lifting activities with more than one person. Even when using lifting supports. The maximum permitted weight for lifting is 25 kg per person.
- Note: Ensure that you use a sufficiently strong lifting tool. The maximum load will be specified on the lifting tool. Incorrectly lifting the gate may lead to gate deformation.
- NOTE:
 - o Ensure that the lifting slings are sufficiently spread out when lifting the wing.
 - o Ensure that the lifting slings are sufficiently load-bearing and are not frayed.
 - o Ensure that the gate is protected.
 - o Do not use chains

Position the post and gate on the washers of the adjusting nuts that have been screwed on to the threaded rods.

Position washers and nuts and manually tighten them.

The mechanical safety endstops that are used to protect the gate during its transport must be slid towards the outside.



The endstops can be used as additional overrun protection, which slightly reduces the clear passage width of the sliding gate.

Adjust the safety endstops to the correct position so that the gate can open and close sufficiently.

Move the gate to the closed position.



IMPORTANT

- Ensure that the passage is free from obstructions.
- Note: entrapment hazard!

Ensure the post and gate are level by adjusting the nuts on the threaded rods at the base plates.

Tighten the nuts.

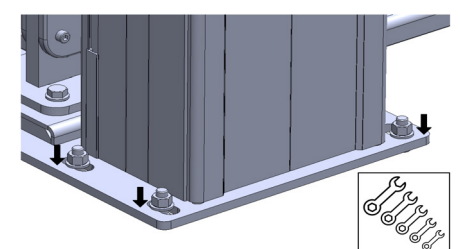
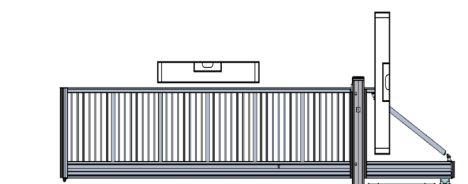
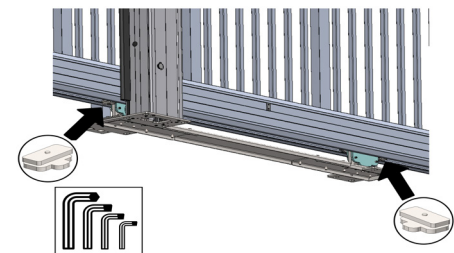
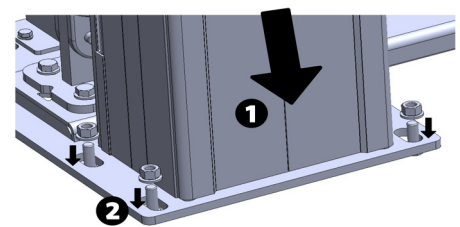
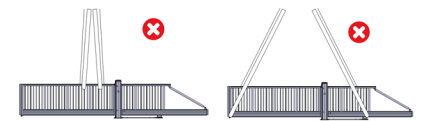
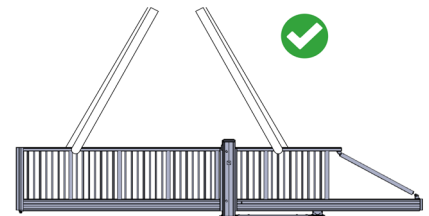

6.5. Installation of the slam portal

Ensure that the gate is in the closed position and determine the position for the slam portal.

Draw the holes on the foundations. Use the base plate as a drawing template. Slightly slide the gate open. Remove the portal and drill the holes with an 18 mm drill bit

Brush the drilled holes;
Clean the drilled holes ensure that all dust and grit has been removed from the drilled hole;
Install the chemical capsules

Insert the threaded rods with a rotational movement in the drilled hole. The threaded rods must at least protrude by 60 mm above the foundations.

Allow the chemical anchors to harden in accordance with the specifications.

Position the slam portal on the threaded rods.
Position washers and nuts and manually tighten them.

Close the gate to such an extent that the support roller or the bottom side of the bottom profile (depending on the gate type) is close to the catching ramp.

Adjust the height of the catching ramp until the space between the gate and the catching ramp is at least 5 mm. Not correctly adjusting this increases the probability of faults because of a pushing force that is too great.

Check the top run-in and set it if required.

Tighten the nuts.

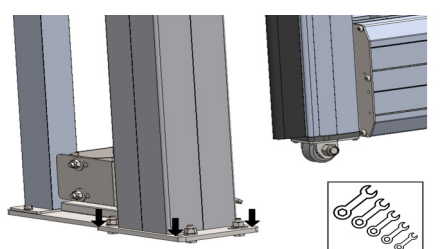
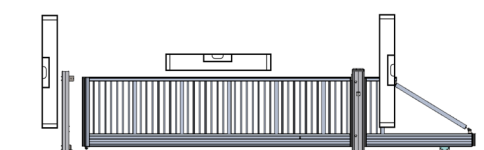
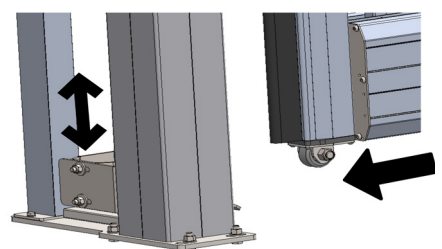
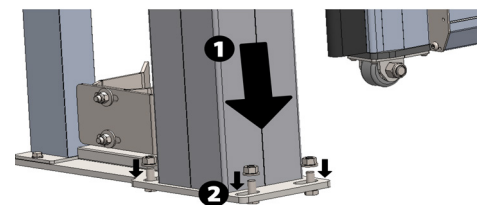
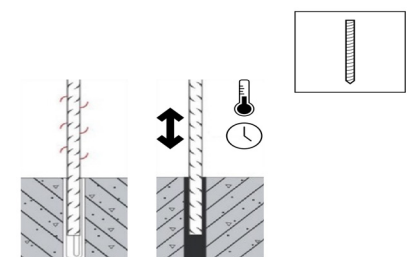
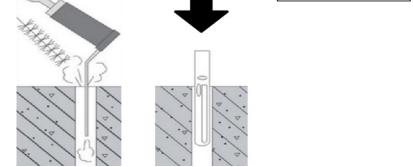
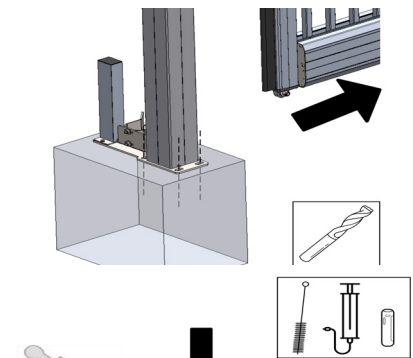
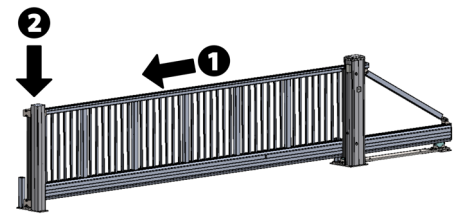

6.6. Installing the rear support roller

Draw the holes on the foundations. Use the base plate as a drawing template (see the foundation plan for distances). Remove the rear support roller and drill the holes with an 18 mm drill bit

Brush the drilled holes.

Clean the drilled holes. Ensure that all dust and grit has been removed from the drilled hole.

Install the chemical capsules.

Insert the threaded rods with a rotational movement in the drilled hole. Allow the chemical anchors to harden in accordance with the specifications.

Position the rear support roller, washers and nuts and tighten them manually.

Set the rear support roller. When opening the gate, the rear support roller must not touch the gate.



NOTE

The gate must not run on the rear support roller in a forced manner. This may damage the gate!

Adjust the height of the rear support roller by turning the nuts. Tighten the nuts using the wrench.

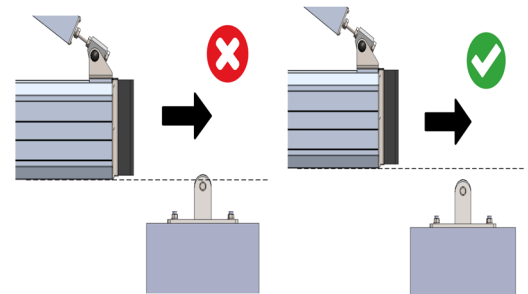
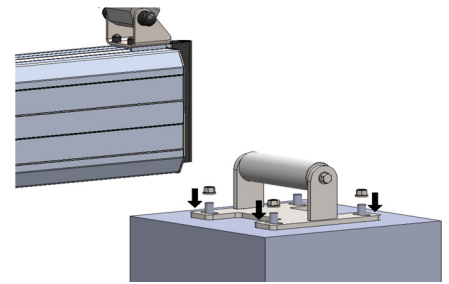
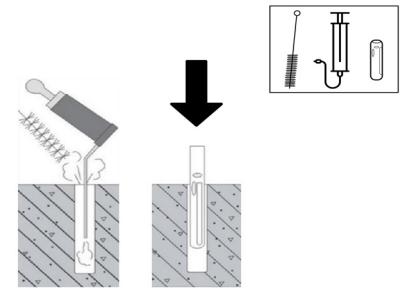

6.7. Underfilling base plate / central catcher



NOTE

All base plates and central catcher of the gate with anchors must be fully supported/shimmed after adjusting the gate to ensure a flush connection (any possible gap between the base plate and the foundation).

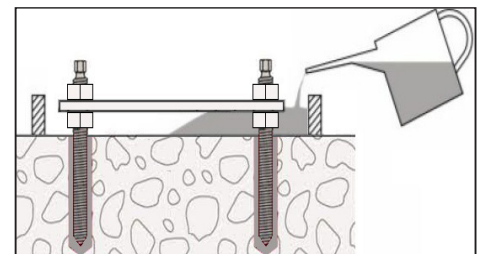

6.8. Lock

Installing the standard lock:

- Place the spacer over the twistfinger, insert the twistfinger through the gate and screw the twistfinger into the lock;
- Make sure that the twistfinger is correct for a left and for a right sliding gate direction;
- Fasten the twistfinger with an insertion screw
- Hold the lock in front of the holes in the wing;
- Place the spacers over the bolts and screw the bolts into the lock;
- Press the protective caps over the bolts;
- Install the handle and cylinder.

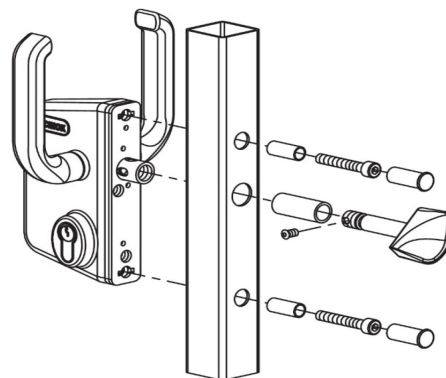

6.9. Gate keep

Installing the standard gate keep:

- Insert the bolts through the counter box;
- Insert the complete counter box through the iron strips of the slam portal;
- Place the gate keep over the bolts and tighten the Slovapanbolts.

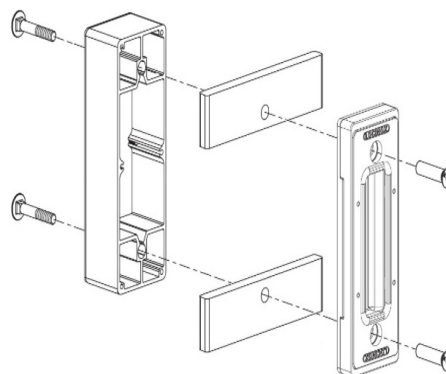

6.10. Wind security handle

Installing the wind security handle:

- Insert the M8 bolts through the wind security handle;
- Screw the bolts in the holes of the post intended for this purpose;
- Fasten the bolts.

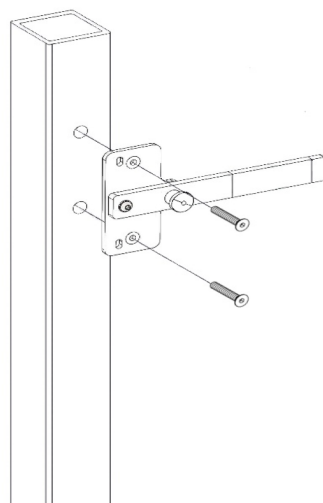

7. Transfer to the user

7.1. Instructions

After installation, the installer must correctly train the user in the use of the gate. Bear the following in mind (this is not an exhaustive list):

- Give an explanation about the general use;
- Give an explanation about the use of the options;
- Give an explanation about applicable legal rules;
- Give an explanation about maintenance and care and possibly a maintenance contract;
- Hand over the user manual;
- Signing off the transfer document;
- Issue of the installer's contact details.



IMPORTANT

- The sliding gate may only be opened or closed under the supervision of and by people with sufficient experience and knowledge regarding the sliding gate
- Only operate an unlocked and manually operated sliding gate with the handle. Use the full handle to avoid the risk of entrapment.
- An uncontrolled movement of the gate wing (for example, caused by wind) must be prevented both in an open and a closed condition. Manual operated sliding gates are standard supplied with a wind security handle and for unlocked automated sliding gates, there are wind security handles available.
- When the gate wing opens or closes in an uncontrolled manner, structural deformation of the gate can occur, which may represent a hazard for people and the surrounding area.
- **An unlocked and manually operated sliding gate may never be opened or closed unsupervised!**

8. Environment, disassembly, storage and transport

8.1. Environment



Recycling

At the end of the product's service life, it must be disposed of separately from other waste.

8.2. Disassembly

Ask about the options on how to dispose of the product within your region when the product will no longer be used. Do not throw away electric equipment and components such as batteries and the accumulator, instead determine whether the product (or its components) can be delivered, recycled or reused.

If you do not have any of these options, skilfully remove all components that can be reused yourself such as metals, fastening materials and electric components. Remove plastic components for recycling.

8.3. Storage and transport

If you want to store or transport the product, make sure that you correctly package the product. The product must be stored in a dry environment.



Aluconnect B.V.

Kokerbijl 9
5443 PV Haps



+31 (0)88 33 43 000



info@aluconnect.nl



www.aluconnect.nl

V25.04

ALUCONNECT